

## Powerful Design For Tough Applications

Conair's Viper Granulator 17-Series granulators are versatile, rugged and designed for central or machine-side recycling of tough, injection molded parts; bulky blow-molded containers; film; sheet; and extruded parts and scrap.

These heavy-duty granulators feature two styles of cutting chamber geometry from super tangential to tangential, allowing you to process virtually any kind of scrap.

Easy pre-adjustment of the gap between rotor and fixed bed knives results in increased throughputs and high-quality, uniform regrind.

Now standard with the "SG" (Smart Granulator) HMI touch screen control.



Model 1724

## Open Access for Easy Cleaning and Maintenance

The robust 17-Series offers a drop-down screen cradle for tool-free chamber access and easy screen removal and rotation. A three-blade (or five-blade), slant-knife open rotor provides scissor-cutting action for fast, efficient processing of even the toughest jobs.

Powered opening and closing of the feeding hopper is standard on the 17-Series. An integrated safety switch prevents accidental powering of the granulator while the feed hopper is open.

Hopper styles to suit all application needs including custom, hand feed, sheet feed, profile feed, roll feed, and conveyor feed.

17-Series options include: high-wear screen and knives, blower evacuation systems, fines removal systems, feed rolls, high-level/high-amp alarms, larger horsepower motors, and incline conveyors with and without a metal detector.

The state-of-the-art SG HMI control is standard and includes auto start/stop, built-in hour meter, lock/unlock screen, data trending and hopper lift control for exceptional oversight and tracking.

### ▶ Quiet operation; simple control

17-Series granulators include soundproofed hoppers on all models; soundproofed base enclosures as standard on models 1724 and 1736, creating the quietest granulator in its class. The SG control gives even novice operators confidence - with intuitive screen design and simple navigation.

### ▶ Hardened cutting chamber

The hardened cutting chamber provides greater resistance to wear.

### ▶ Direct, safe and easy access to machine core

Conair's innovative 17-Series cutting chamber features a drop-down screen cradle and removable discharge bin. Complete rotor access greatly simplifies clean out and blade maintenance saving you time and money. Integral safety interlocks prevent accidental operation during service or clean out.

### ▶ Greater screen area equals higher throughput with fewer fines

Increased rotor and screen contact area reduces heat generation and minimizes fines for best-in-class throughput of higher quality regrind.

### ▶ Pre-Adjustable knives with scissor-cutting

Provides the ultimate in blade changes. The scissor-cutting knives are pre-set in the included knife setting fixture decreasing the time it takes to replace knives while improving safety and delivering the highest quality regrind.

### ▶ Water-cooled cutting chamber

Keeping the cutting chamber cool when handling heat sensitive or hot material increases granulate quality while decreasing the risk of downtime associated with screen clogging.



## Features

- Soundproof hopper
- Soundproof base (standard on models 1724 and 1736)
- Rotor equipped with rotating end disks
- Roller bearings mount integral with cutting chamber
- Flywheel-type rotor pulley mounted with taper-lock bushing
- Rotor "zero speed" sensor
- Stationary rotor lock for safe cutting chamber maintenance
- Easy tool-free access for quick and simple cleaning and maintenance
- Powered hopper opening and closing
- 3- or 5-knife rotor with steep angle cutting configuration
- Scissor-cutting configuration
- Pre-adjustable knives
- Open area screen equal to approximately 50% of the rotor diameter
- Hardened cutting chamber
- Water-cooled cutting chamber
- NEMA control panel
- Pallet-style base with vibration foot mounting
- Discharge for blower evacuation



Water-cooled cutting chamber

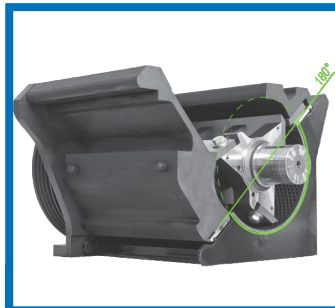

Screen equal to approximately 50% of the rotor diameter

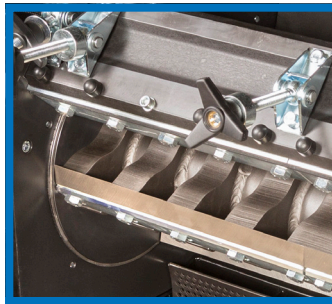

Rotor equipped with rotating end disks



Scissor-cutting configuration

## Options

Model	1724	1736	1748	1760
<b>Options</b>				
High-wear knives and screens	<input type="radio"/>	<input type="radio"/>	<input type="radio"/>	<input type="radio"/>
Soundproof base	<input checked="" type="radio"/>	<input checked="" type="radio"/>	<input type="radio"/>	<input type="radio"/>
Feed tray	<input type="radio"/>	<input type="radio"/>	<input type="radio"/>	<input type="radio"/>
Funnel for conveying feed	<input type="radio"/>	<input type="radio"/>	<input type="radio"/>	<input type="radio"/>
Large volume hopper	<input type="radio"/>	<input type="radio"/>	<input type="radio"/>	<input type="radio"/>
Feed roll package	<input type="radio"/> *	<input type="radio"/> *	<input type="radio"/> *	<input type="radio"/> *
Hopper for pipes and sheets	<input type="radio"/> *	<input type="radio"/> *	<input type="radio"/> *	<input type="radio"/> *
Hopper for relief head	<input type="radio"/>	<input type="radio"/>	<input type="radio"/>	<input type="radio"/>
Anti-longs screen	<input type="radio"/>	<input type="radio"/>	<input type="radio"/>	<input type="radio"/>
Main electrical disconnect	<input type="radio"/>	<input type="radio"/>	<input type="radio"/>	<input type="radio"/>
High-amp control with alarm	<input type="radio"/>	<input type="radio"/>	<input type="radio"/>	<input type="radio"/>
High-level control with alarm	<input type="radio"/>	<input type="radio"/>	<input type="radio"/>	<input type="radio"/>
Blower evacuation systems	<input type="radio"/>	<input type="radio"/>	<input type="radio"/>	<input type="radio"/>
Feed conveyor with metal detection	<input type="radio"/>	<input type="radio"/>	<input type="radio"/>	<input type="radio"/>
SG HMI touch screen control	<input checked="" type="radio"/>	<input checked="" type="radio"/>	<input checked="" type="radio"/>	<input checked="" type="radio"/>

● Standard    ○ Available    \* Not available on the super tangential configuration

### 17-Series Cutting Chamber Configurations

#### Super-Tangential Chamber

Designed specifically to efficiently granulate large, bulky parts for blow molding and injection molding applications increasing throughput and improving regrind quality.



#### Tangential Chamber

Designed for the granulation of extruded sheet, profiles, and pipe as well as for high throughputs of pre-shredded material. Available with a 3-blade or 5-blade rotor.

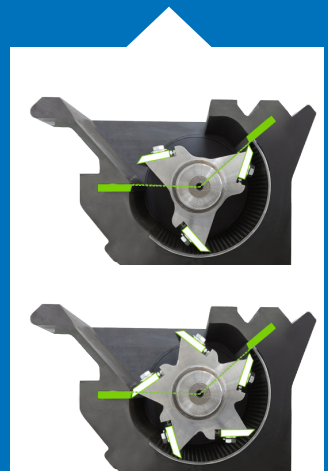

# Feeding/Evacuation Configurations

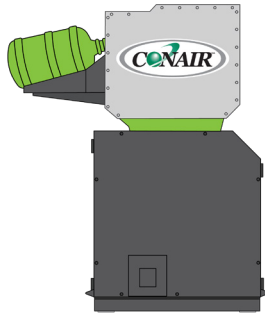

### Hand Feeding

Standard feeding method. Flyback minimized by rugged curtains. Feed tray may be rotated up to close off opening; down to feed scrap.

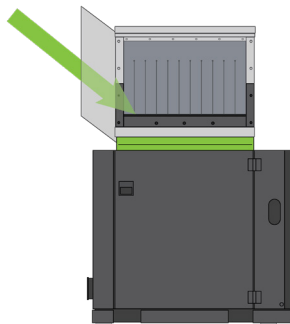

### Side Feeding

Commonly required for long extruded parts and scrap. Preliminary cutting, folding or breaking of scrap is not required, since feed chute delivers scrap directly to rotor knives.

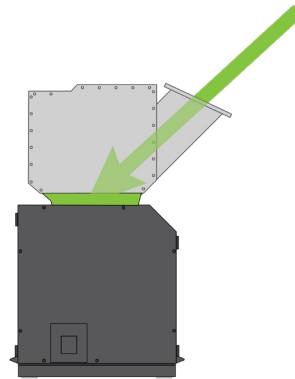

### Rear Feeding

Commonly used for sheet and other wide scrap, the angled chute is as wide as the cutting chamber and scrap is fed directly into the rotor knives.

### Roll Feeding

For film scrap on rolls (IE: film extrusion start-up scrap), feeding is automatically controlled by speed-controlled pinch rollers slaved to the amperage of the granulator drive and/or the closed-loop film reclaim system.

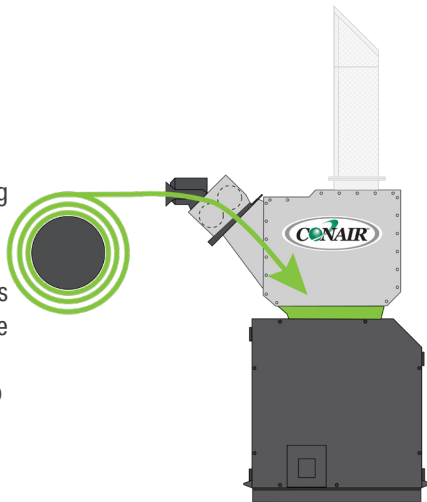

### Relief Head Feeding

Thin strips of film edge trim and other film products are transferred to the granulator by a blower system and the conveying air is exhausted by the screen shell of the relief head.

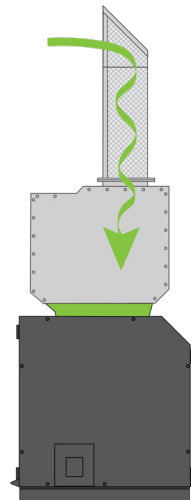

# Feeding/Evacuation Configurations

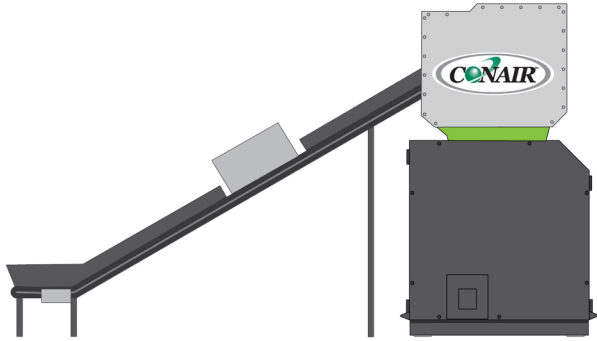

### Conveyor Feeding

Optimized, meter feeding of scrap by a speed-controlled conveyor. Conveyor speed can be linked to granulator drive motor amps. Conveyor can include a metal detector that stops conveying when metal in the scrap is detected.



### Cyclone Head Feeding

For near continuous feeding of tabs and tails, small scrap/parts fed from a blower.

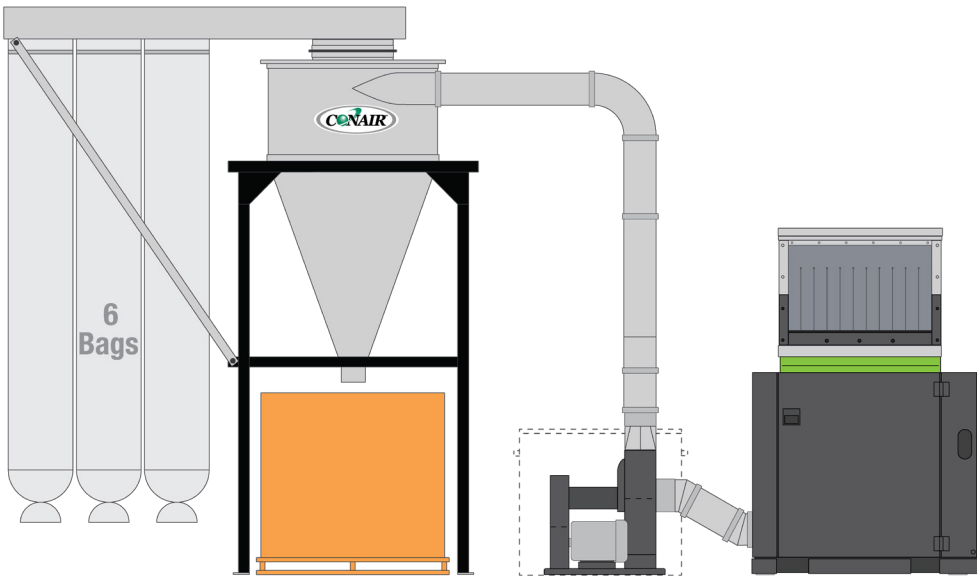

### SRB Cyclone Evacuation

Fully optimized evacuation by a blower and cyclone system assures the granulator never overfills, while granulate is cooled by the blower's air flow.



# SG (Smart Granulator) Control Features

**Multi-level User Security**  
Identify User and Log-in Status

**Simple Menu Operation**  
Access to all features

**Alarm Lists, History, and Details**  
Operators can drill down from the Alarm List to the Alarm History and Alarm Details screens to analyze issues. Alarm details are specific, with recommended corrective actions.

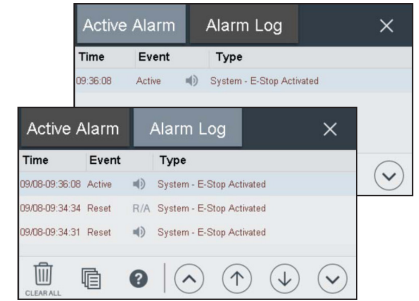
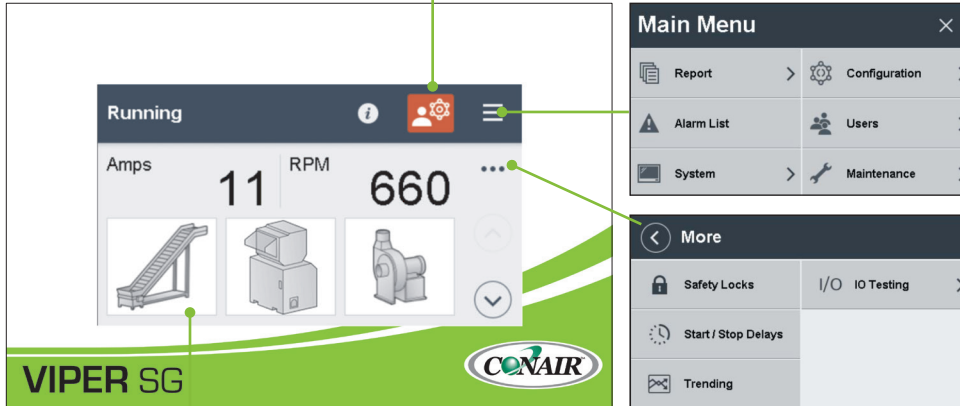

**Touch Screen Display**  
Large, customizable Home screen display with current Amps & RPM

**Trending**  
Follow the performance of the machine using RPMs and AMPs. These trends demonstrate screen, knife, and motor performance.

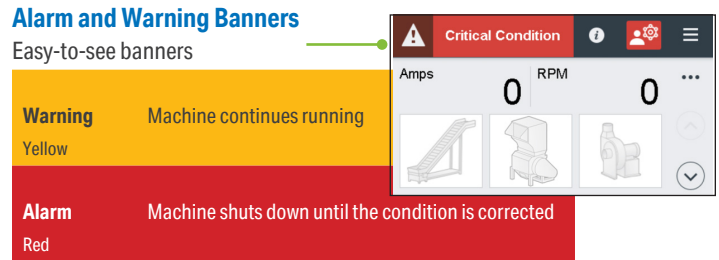
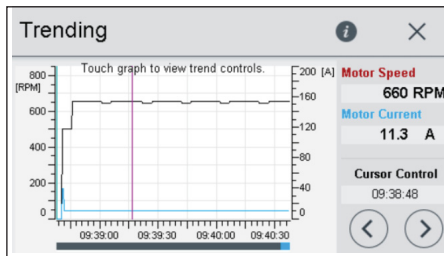

**Contextual Help Mode**  
On-screen descriptions of features when touched

## Optional Basic Control Features

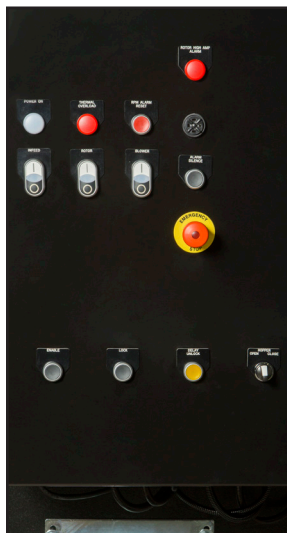

**Easy to Read Buttons**  
Basic on/off of the blower, rotor, and in-feed buttons

**Alarm Silencer**  
Quickly turn off alarms

**Accessible Lock /Delay Unlock**  
Lock and delay unlock conveniently located at the top of the control

## Control Feature Comparison

Control Features	SG	Basic
On/Off of the Blower, rotor, in-feed	●	○
Alarm Silence	●	○
Lock	●	○
Delay Unlock	●	○
AutoStart/AutoStop*	●	
AutoStart/AutoStop Membrane Switch	●	
Lock/Unlock screen †	●	
Data Trending (RPM and Amps)	●	
Built-in hour meter	●	
Audible and visual alarms	●	○
Communications - Modbus-TCP, OPC-UA	●	
Hopper Lift Control	●	○

● Standard      ○ Optional

**Notes**

\* AutoStart and AutoStop turn on and off all of the connected equipment (infeed, granulator, outfeed) in order, with editable delays between each device.

† Initiates lock and unlock process. Identifies any safety locks that are open and closed for simple troubleshooting.



# Specifications

## Granulator with standard hand feed hopper

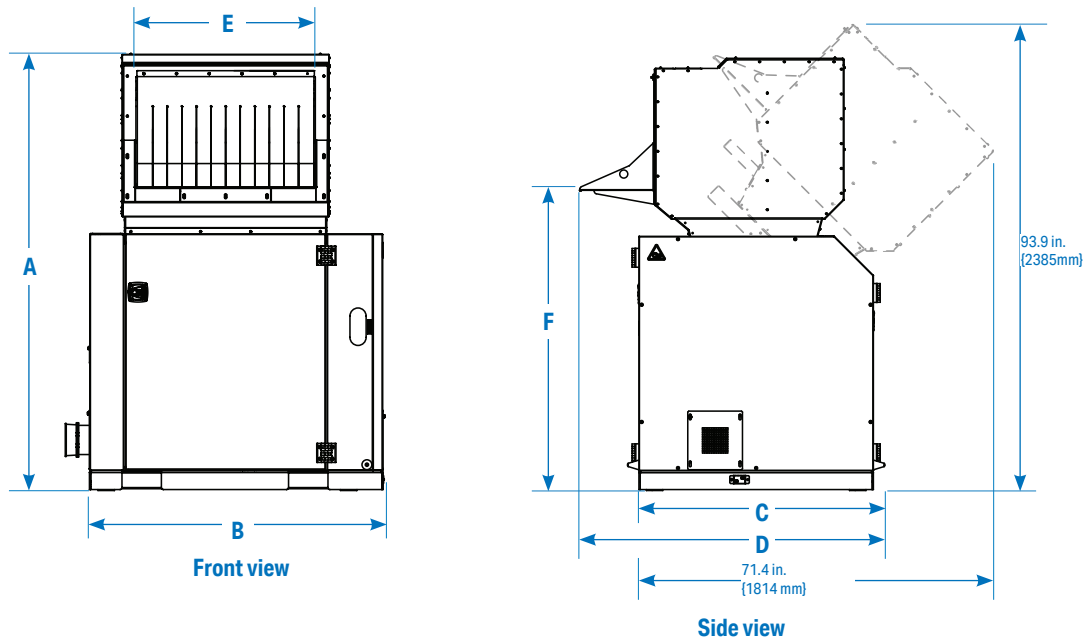

**Application Note**  
 Allow appropriate clearance above machine for hopper tilting during maintenance.

Models	1724	1736	1748	1760
<b>Performance characteristics</b>				
Throughput range † lb/hr {kg/hr}	up to 1350 {612}	up to 2000 {907}	up to 2700 {1225}	up to 3600 {1633}
Rotor diameter inches {mm}	14.2 {360}			
Rotor speed rpm	615 at 60 Hz			
Rotor type	3-blade or 5-blade welded open rotor			
Rotating knives x fixed knives	3 x 2; optional 5 x 2			5 x 2
Standard screen hole size inches {mm}	11/32 {9}			
Cutting chamber inches {mm}	16.5 x 24.5 {420 x 620}	16.5 x 35.8 {420 x 910}	16.5 x 47.2 {420 x 1200}	16.5 x 59.1 {420 x 1500}
Motor power Hp {kW} (standard)	30 {22}	40 {30}	50 {37}	
Motor power Hp {kW} (optional)	25 {19}, 40 {30}, 50 {37}	30 {22}, 50 {37}	40 {30}, 60 {45}	60 {45}
<b>Dimensions inches {mm}</b>				
A - Height	87.1 {2212}			
B - Width	47.6 {1210}	58.7 {1490}	72.4 {1840}	90.6 {2300}
C - Depth	47.2 {1200}			
D - Overall depth	60.5 {1537}			
E - Feed hopper opening width	24.4 {620}	35.4 {900}	49.2 {1250}	59.0 {1500}
F - Height to hopper infeed	61.0 {1549}			
<b>Approximate weight lb {kg}</b>				
Installed	4202 {1910}	5170 {2350}	6160 {2800}	7480 {3400}
Shipping	5300 {2410}	6300 {2865}	7500 {3410}	9000 {4090}
<b>Voltages Full load amps based on motor size †</b>				
Motor power Hp	30 {22}	40 {30}	50 {37}	
230/3 phase/60 Hz	70.2	94.2	N/A	
460/3 phase/60 Hz (standard)	35.1	47.1	59.2	
575/3 phase/60 Hz	28.1	37.7	47.4	

### Specification Notes

- \* Throughputs are provided as a capacity guideline only. Throughput will be greater or lesser than the values shown according to the selected screen size and the shape, size, thickness and properties of the material to be cut. Consult Conair for a material test to help in determining the correct granulator model for your application.
- † FLA data for reference purposes only. Does not include any accessories added such as blower or conveyor motor loads. Includes standard motor only. For true, full FLA for power circuit design of specific machine refer to electrical diagram of the machine order or nameplate applied to machine at shipment. Specifications may change without notice. Check with a Conair representative for the most current information.

